

**MINIO**  
OBJECT STORAGE

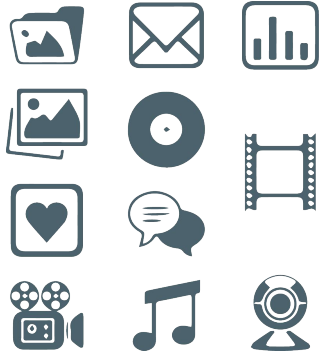

# UNSTRUCTURED



## IMMUTABLE DATA

(Logs, Video, Archive, Documents, VMs / Containers)



# STRUCTURED

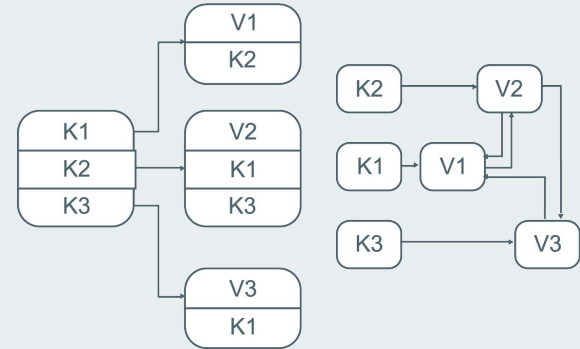

## MUTABLE DATA

(Index, Metadata)



# MINIO OBJECT STORAGE STACK



MINIO SERVER











MINIO CLIENT



MINIO SDK

Search Buckets...

-  danielfrg
-  deveng-s3
-  dog
-  download
-  ebl1jgbqumjh5p4168tn818...
-  elvizlai-music
-  europetrip
-  fsfs
-  play.minio.io:9000

danielfrg /

Used: 40.54 GB

Free: 588.92 GB



Name	Size	Last Modified
------	------	---------------

 .ipynb_checkpoints/	-	-
 __pycache__/	-	-
 s3contents.org-pro/	-	-
 s3contents/	-	-
 .DS_Store	6.00 KB	Oct 20, 2016 4:07 PM
 .gitattributes	36 bytes	Oct 20, 2016 4:07 PM
 .gitignore	858 bytes	Oct 20, 2016 4:07 PM
 LICENSE	11.08 KB	Oct 20, 2016 4:07 PM



# CLOUD-NATIVE ARCHITECTURE

Provision object storage as **containers**

Containers

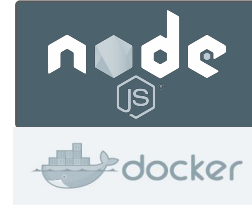
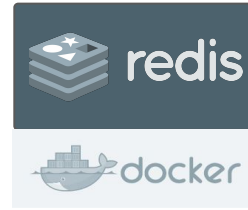
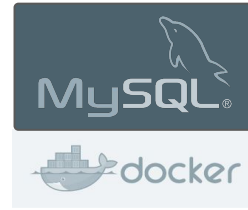

Orchestration



Infrastructure

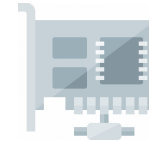
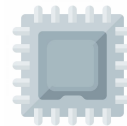

# ERASURE CODE & BIT ROT PROTECTION

## OBJECT ERASURE-CODED OVER 16 DRIVES

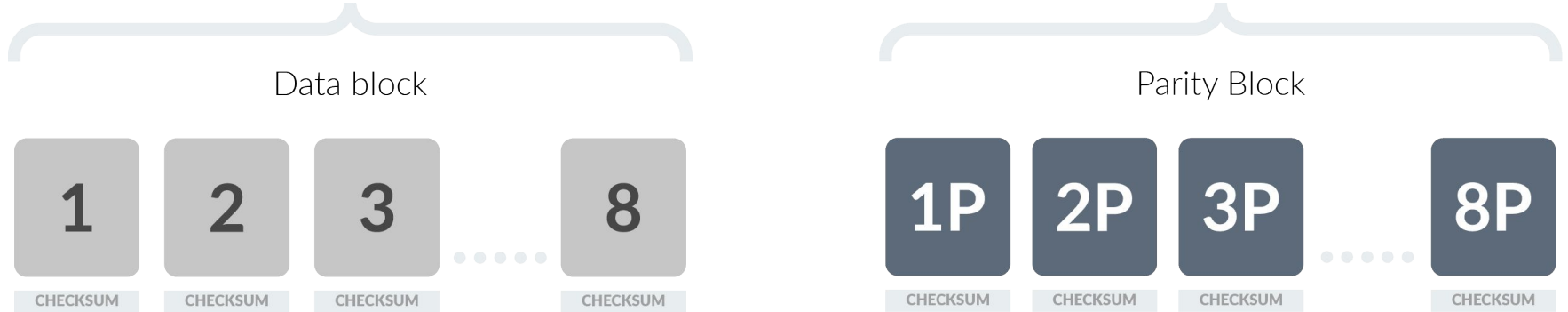

# REPLICATED SETUP



Minio



Minio



Amazon S3



Google  
Cloud Storage

**Continuously Mirror**

between any S3 compatible cloud storage service



# LAMBDAFUNCTIONS



elasticsearch

**Elasticsearch** is a search engine based on Lucene. It provides a distributed, multitenant-capable full-text search engine with an HTTP web interface and schema-free JSON documents.

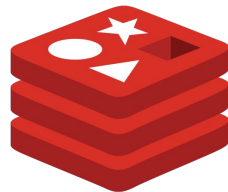

**REDIS** is an open source (BSD licensed), in-memory data structure store, used as database, cache and message broker. It supports data structures.



PostgreSQL

**PostgreSQL** is an open source relational database management system (DBMS) developed by a worldwide team of volunteers.



**AMQP** is an open standard application layer protocol for message-oriented middleware. Its defining features are message orientation, queuing, routing, reliability and security.



**Kafka** is an open-source message broker project developed by the Apache Software Foundation. The project aims to provide a unified, high-throughput, low-latency platform for handling real-time data feeds.



**Nats IO** is a simple, high performance open source messaging system for cloud native applications, IoT messaging, and microservices architectures.



# MINIOUSAGE

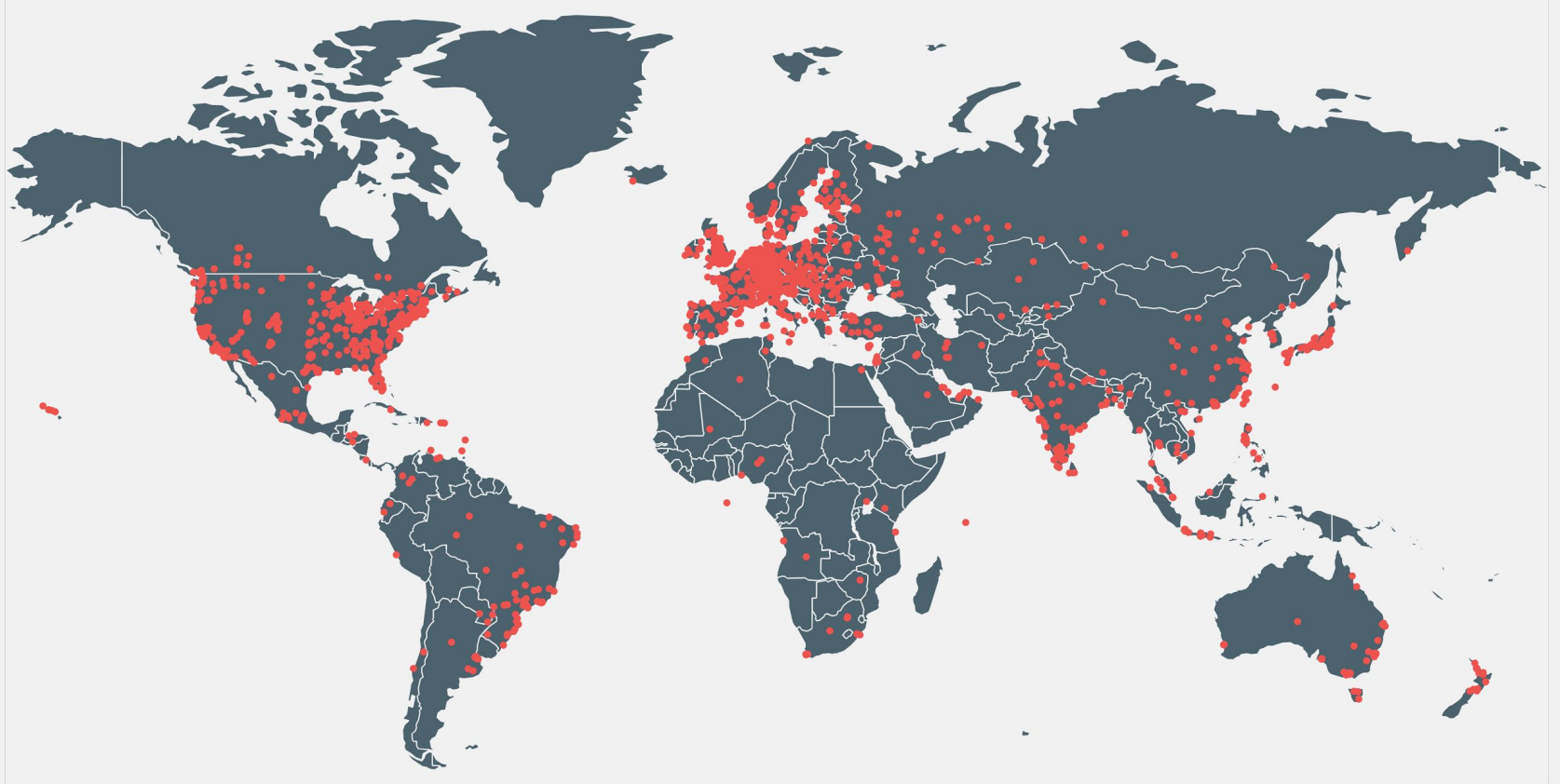

# COMMUNITY ADOPTION

## SaaS

CALISTREAM



Crisp



Simple Simple



trust VOX  
sinceridade não tem preço.



GitLab

CODECASTS

blockai



drone.io



Pathio

TransferXL

DBhub.io

## Enterprise

MCKESSON



appknex



Mattermost



DragonDisk



Houbank

## IaaS



Azure



packet



Hyper.SH

HETZNER  
ONLINE



Google Cloud

SSDNODES

scaleway

OnLINE TECH

## Open Source

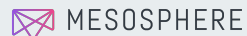

CLOUD FOUNDRY



Rclone



Mountain Duck



CyberDuck



Restic



S3 GIT

django

TARANTOOL

mkrepo



Dokku



Plumberry

## Dev Shop



Forest Giant



Collaborne



CODIUM

s3-resource-simple

# Thank You



<https://minio.io>



<https://docs.minio.io>



<https://blog.minio.io/>



# DEVELOPER ADOPTION



RED HAT  
CEPH



OPENSTACK  
SWIFT



MINIO

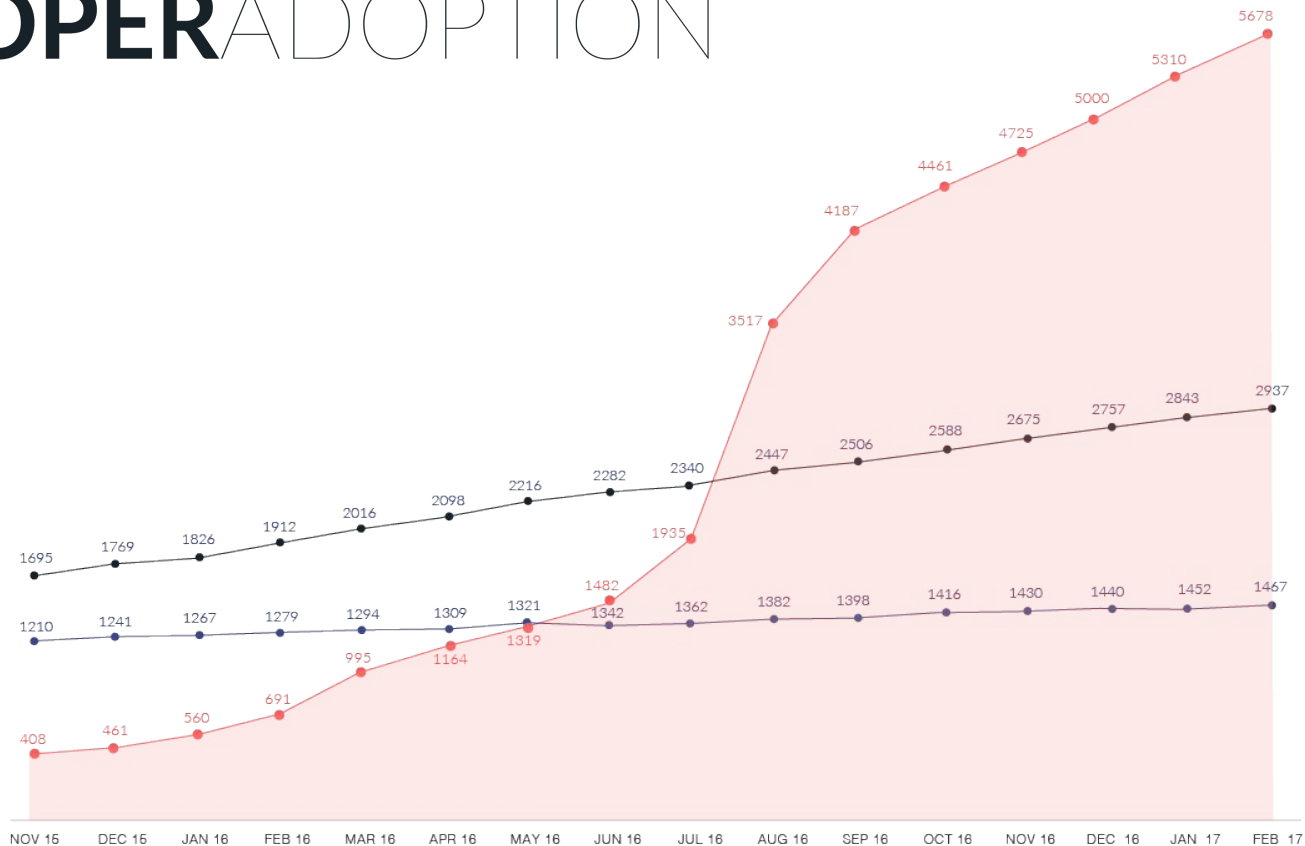

Github Star trend line for Open-source Object Storage



# RISE OF UNSTRUCTURED DATA

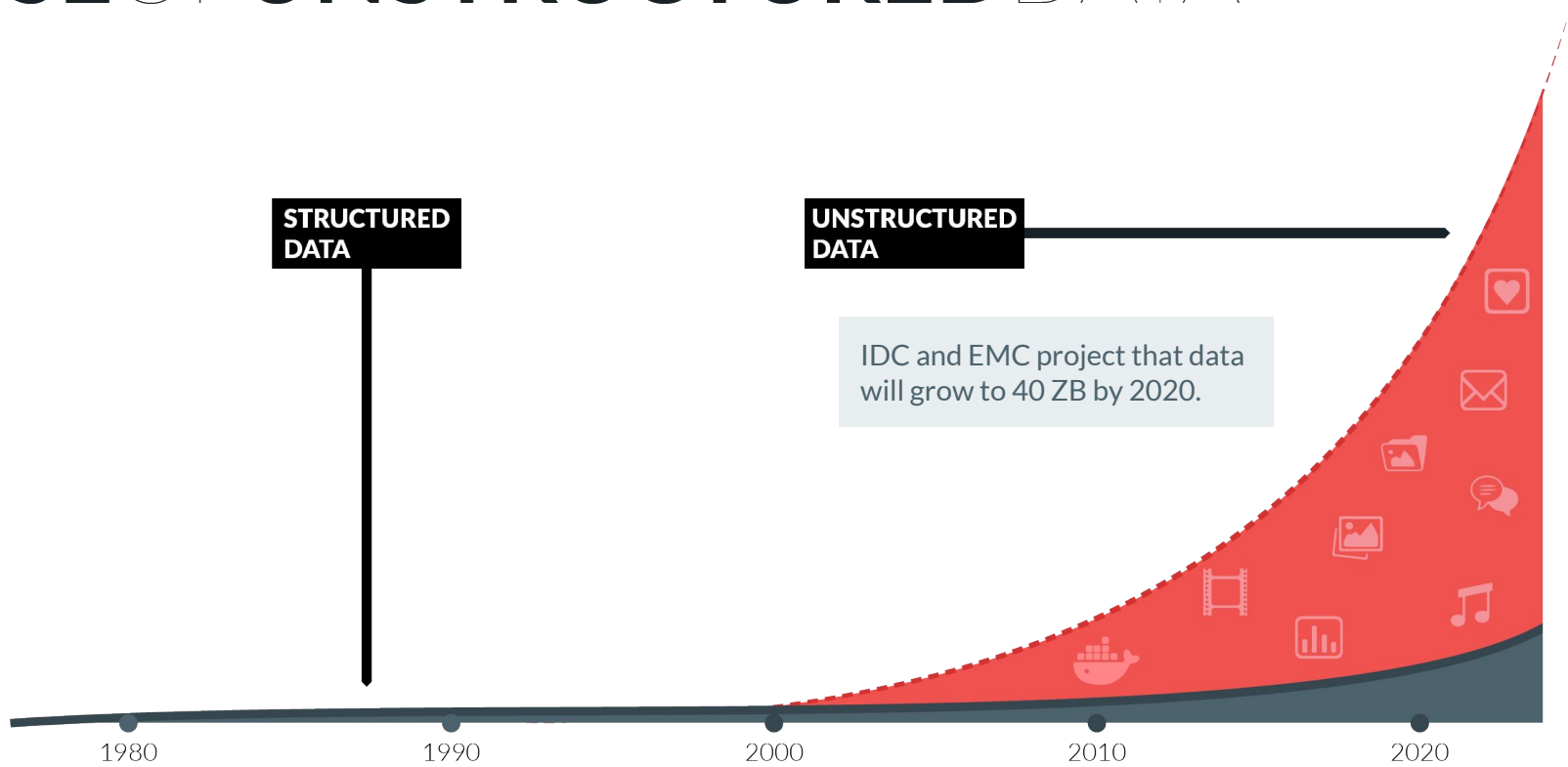

# REFERENCE HARDWARE FOR PETASCALE STORAGE

## SMC [5018A-AR12L](#) (Intel Atom)

SMC 1U SoC Atom C2750 platform with  
12 x 3.5" drive bays

## Cisco [UCS C240](#) M4 Rack Server

Cisco 2U DP E5-2600v3 platform with  
12 x 3.5" drive bays



Cisco UCS C240

## Quanta Grid [D51B-2U](#) (OCP Compliant)

Quanta 2U DP E5-2600v3 platform with  
12 x 3.5" drive bays

## Intel® Server System [R2312WTTYSR](#)

Intel 2U DP E5-2600v3 platform with  
12 x 3.5" drive bays

